



SPEC SHEET

KoolMore 12" x 30" Stainless Steel Floor Trough Drain, 14-Gauge with Subway-Style Grating & Removable Drain Basket, NSF Listed

Model: KM-FTG-1230

FEATURES

- 14-gauge 304 stainless steel resists corrosion.
- 4-inch drain with 3-degree slope for fast drainage.
- Subway-style grate handles traffic and debris.
- Supports 728 lbs. and holds 9.77 gallons.
- Removable basket for easy maintenance.
- NSF certified with a 2-year warranty.



CLOSE UP IMAGES



TECHNICAL SPECS

Dimensions

Length	32
Width	14
Height	7
Interior Depth	12
Interior Width	30
Interior Height	4
Weight Lbs	45

Features & Materials

Top Capacity	662 lbs.
Water Capacity	4.23 gal.
Exterior Material	Stainless-Steel 304
Gauge Of Stainless Steel	9 & 14
Color Finish	Stainless-Steel
Grate Thickness	
Diameter Of Drain Line Connection	4 in.
Included	1 Drain Basket
Angle Of Downward Incline In Basin	3 degrees

Certification

Certifications	NSF Listed
----------------	------------

Plan View

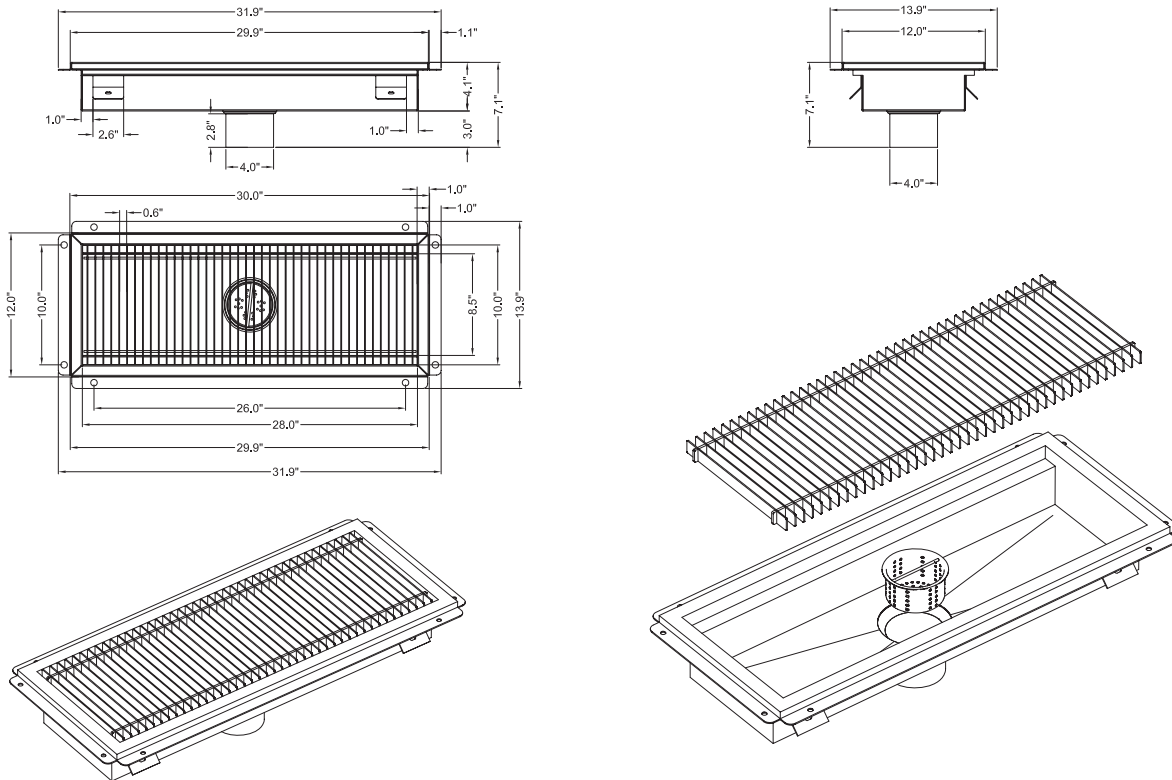

CERTIFICATIONS



706 Eastern Parkway STE 1G, Brooklyn NY 11213
718-576-6342
info@koolmore.com